

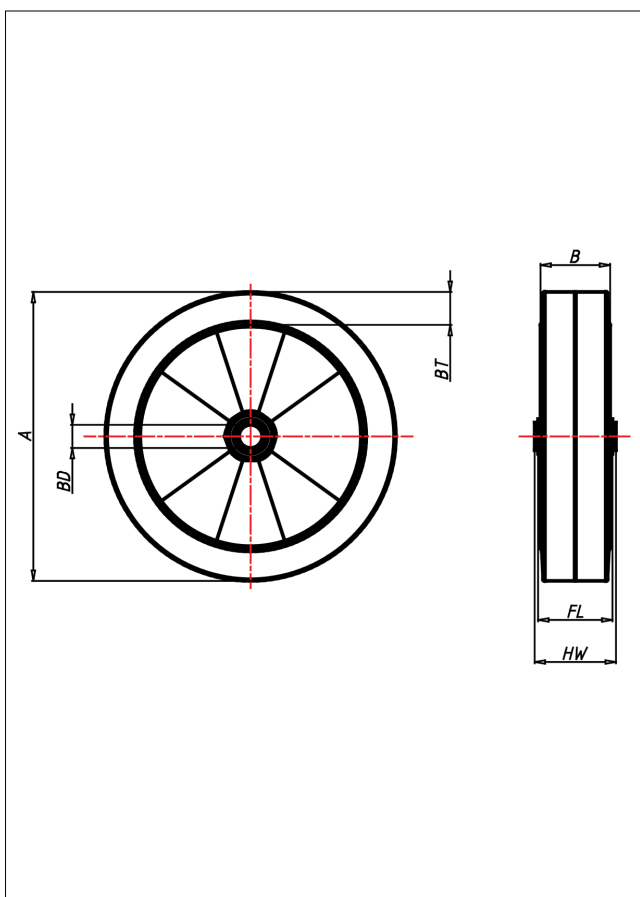

E Rad



E



Radkörper aus Spritzguss-Aluminiumlegierung
Elastik-Vollgummireifen, schwarz oder grau,
73±5 Shore A, aufvulkanisiert

- hoher Fahrkomfort
- sehr lauffähig
- geringer Rollwiderstand
- abriebfest
- korrosionsbeständig
- spurfrei in grau

Technische Details

ORDERNO (Artikel-nummer)	300 EK 30
WDAB (Rad-Ø A x Breite B / mm)	300x60
LC (Tragkraft / kg)	700
BT (Reifenstärke / mm)	31
HW (Nabellänge / mm)	75
FL (Einbaulänge / mm)	74
WB (Radlager)	2 Rillen-Kugellager 6206 ZZ
BD (Bohrungsdurchmesser / mm)	30